

**KitchenAid®**  
**CUSTOM**

**BUILT-IN DISHWASHER**

**MODEL KDC-21AD / MODEL KUDC21D**

**USE & CARE GUIDE**

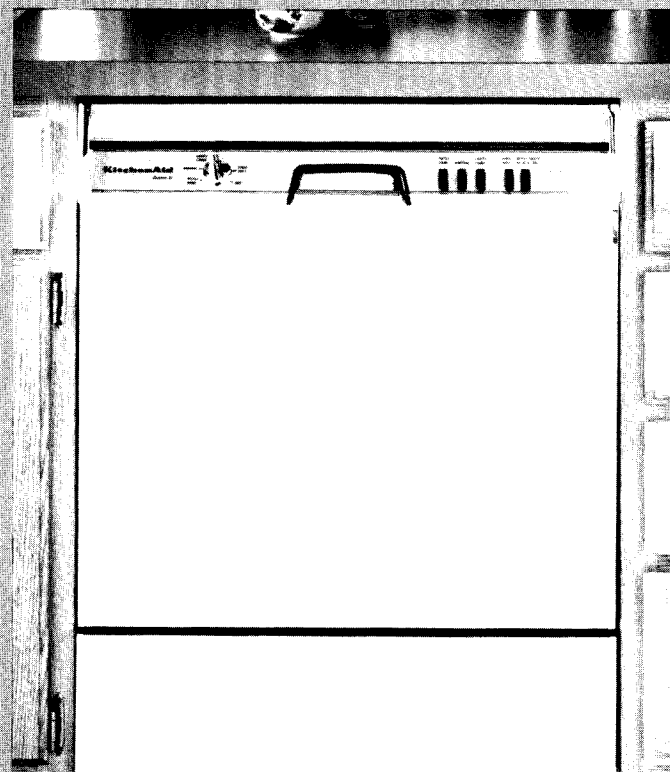

417728

[REDACTED]

[REDACTED]  
[REDACTED]  
[REDACTED]  
[REDACTED]  
[REDACTED]  
[REDACTED]  
[REDACTED]  
[REDACTED]  
[REDACTED]



## IMPORTANT SAFETY INSTRUCTIONS

**WARNING:** When using your dishwasher, follow basic precautions, including the following:

1. Read all instructions before using the dishwasher.
2. This dishwasher must be properly grounded; see Installation Instructions for details.
3. Use the dishwasher only for its intended function.
4. Use only detergents or wetting agents recommended for use in a dishwasher, and keep them out of the reach of children.
5. When loading items to be washed:
  - a. Locate sharp items so that they are not likely to damage the door seal.
  - b. Load sharp knives with the handles up to reduce risk of cut-type injuries.
6. Do not wash plastic items unless marked "dishwasher safe" or the equivalent. For plastic items not so marked, check the manufacturers' recommendations.
7. Do not touch the heating element during or immediately after use.
8. Do not operate your dishwasher unless all enclosure panels are properly in place.
9. Do not tamper with controls.
10. Do not abuse, sit on or stand on the door or dish rack of the dishwasher.
11. To reduce the risk of injury, do not allow children to play in or on a dishwasher.
12. Under certain conditions, hydrogen gas may be produced in a hot water system that has not been used for two weeks or more. *Hydrogen gas is explosive.* If the hot water system has not been used for such a period, turn on all hot water faucets and let the water flow from each for several minutes. This will release any accumulated hydrogen gas. Since the gas is flammable, do not smoke or use an open flame during this process.
13. Remove the door to the washing compartment when removing an old dishwasher from service or discarding it.

## SAVE THESE INSTRUCTIONS



## TABLE OF CONTENTS

	<b>Page</b>
Important Safety Instructions .....	3
Ownership Registration Card .....	5
Important Facts .....	6
Get To Know Your Dishwasher.....	7
Operating Your Dishwasher.....	8
Sounds You May Hear .....	8
Automatic Water Heating .....	9
Energy Saving Tips .....	9
Dishwasher Cycles.....	10-11
To Cancel A Cycle.....	11
Adding Dishware During A Cycle .....	11
Special Tips On Dishwasher Use.....	12
Loading Your Dishwasher.....	13-17
Upper Rack.....	14-15
Lower Rack.....	16
Silverware Basket.....	17
Filling The Detergent Dispenser .....	18
How Much Detergent To Use .....	19
Low Phosphate Detergents .....	19
Rinse Agents .....	19
Caring For Your Dishwasher .....	20
Seasonal Storage .....	20
Sure-Clean Wash System .....	22-23
Problem, Cause, Solution Chart.....	24-26
To Remove Spots And Film .....	26
Changing Front Panels.....	27-29
Optional Front Panels .....	29
When You Need Service .....	30
Warranty.....	Back Cover



## OWNERSHIP REGISTRATION CARD

### Take a minute...

Before you use your dishwasher, please fill out and mail your ownership registration card packed with the Use and Care Guide. This card will enable us to contact you in the unlikely event of a product safety notification and assist us in complying with the provisions of the Consumer Product Safety Act. **THIS CARD DOES NOT VERIFY YOUR WARRANTY.**

Keep a copy of the sales receipt showing the date of purchase and or date of installation of your dishwasher. **PROOF OF PURCHASE WILL INSURE YOU OF IN-WARRANTY SERVICE.**

Write down the following information. You will need it if your dishwasher ever requires service.

Model Number\* \_\_\_\_\_

Serial Number\* \_\_\_\_\_

Date Purchased \_\_\_\_\_

Date Installed \_\_\_\_\_

Dealer's Name \_\_\_\_\_

Address \_\_\_\_\_

Phone \_\_\_\_\_

\*Model and Serial Numbers are located on a label at the left side of the door opening.



## **IMPORTANT FACTS**

### **You Should Know That...**

- KitchenAid dishwashers operate on 115 volts, 60 hertz A.C. house current. They *cannot* be converted to operate on 220 volts, 50 hertz house current.
- To protect against possible rupture of fill valve, **BE SURE** water lines leading to the dishwasher as well as water lines in the dishwasher are protected against freezing. Such ruptures are *not* covered by the warranty.
- The door hinges or latch mechanism of your dishwasher should be removed if you discard or otherwise remove your dishwasher from service. In California, it is a misdemeanor for anyone discarding the appliance not to follow this safety procedure. This extra step can save the lives of curious children at play.

## GET TO KNOW YOUR DISHWASHER

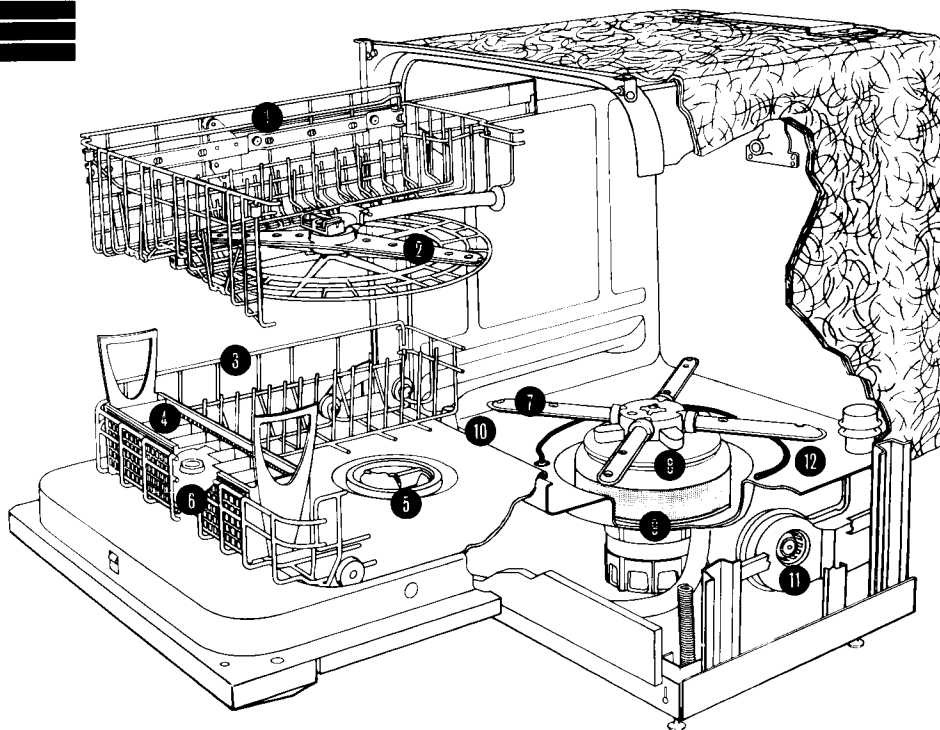

### The Inside Story

1. 16-Position Adjustable Upper Rack
2. Upper Level Power Wash With ChinaGuard
3. Lower Rack
4. Cutlery/Silverware Basket
5. Detergent Dispenser
6. Automatic Rinse Agent Dispenser
7. 4-Way Hydro Sweep Wash
8. Self-Cleaning Filter With Jet Spray
9. Removable Coarse Strainer
10. Overflow Protection Float
11. Flo-thru Drying Fan
12. Water Heating and Drying Element



## **OPERATING YOUR DISHWASHER**

Step 1... Load dishes into racks according to instructions on pages 14 through 16. **DO NOT OPERATE DISHWASHER WITHOUT RACKS IN PLACE.**

Step 2... Add detergent to detergent dispenser. See page 18.

Step 3... Firmly close the door and latch it by pushing the door handle down.

Step 4... Push button for desired cycle.

Step 5... Advance Cycle Selection Dial slowly to corresponding cycle. See page 10 for description of cycles.

Note: If Step 5 is omitted, the timer will automatically advance to the cycle selected in Step 4. However, this requires more time than advancing the dial manually.

### **Sounds You May Hear While Your Dishwasher is Running:**

- the fill valve opening or closing and the sound of water entering the dishwasher
- water being pumped out during drain portion of cycle
- detergent cup opening
- timer clicking as it advances or resets
- pump motor starting





## **AUTOMATIC WATER HEATING**

Your KitchenAid dishwasher offers automatic water heating. An incoming water temperature of 120°F is recommended at the dishwasher for best washing results.

### **To Check Your Water Temperature**

For best dishwashing results, water should be at least 120°F (49°C) as it enters the dishwasher. To check the temperature, use the faucet closest to your dishwasher.

1. Set the faucet control for the hottest water possible. Run water into a glass set in the sink for at least one minute, allowing it to overflow.
2. Place a candy or meat thermometer in the glass and read it at the maximum setting.
3. If the temperature is too low, raise the setting on your water heater.

## **ENERGY SAVING TIPS**

### **Power to Spare...**

- Use the ENERGY SAVER—NO HEAT DRY option whenever possible. If you don't need your dishes right away, it pays to air dry them.
- Flash dry dishes. After final rinse, unlatch door and advance Cycle Selection Dial to Pots/Pans Cycle; open door and pull out racks. Because of the heat buildup in dishware during the wash cycle, water evaporates quickly from the dishware.  
**NOTE:** In hard water areas, flash drying can increase the likelihood of spotting and filming.
- Turn the temperature setting on your home water heater down to provide a minimum of 120°F (49°C) incoming water to the dishwasher.
- Run the dishwasher only with a full load.
- Do not rinse dishware before loading.
- Use only the cycle and options that you need.
- Run the dishwasher at night during the summer to avoid daytime heat load.

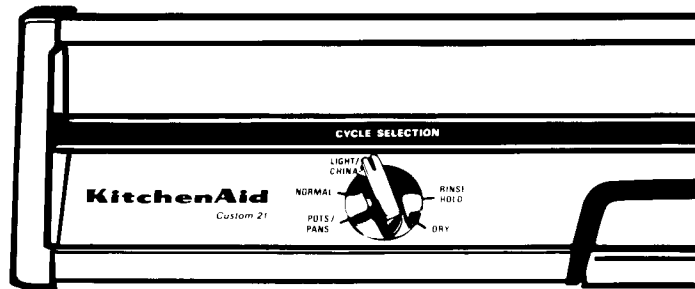

## SELECT A WASH CYCLE

**LIGHT/CHINA WASH CYCLE** is used to wash and dry daily loads with light amounts of food soil. This cycle uses less water and time than the other wash cycles and is the most energy efficient cycle to use.

What happens during this cycle?

There are two wash periods with one final after rinse followed by a heated dry period.

**NORMAL WASH CYCLE** is used to wash and dry daily loads with light amounts of food soil.

What happens during this cycle?

There are two wash periods each with an after rinse followed by a heated dry period.

**POTS/PANS CYCLE** is used to wash and dry hard-to-clean, heavily soiled pots, pans and casseroles along with regular tableware. Choose this cycle for the toughest jobs.

What happens during this cycle?

There are three wash periods with two after rinses followed by a heated dry period.

**NOTE:** All cycles may be used to wash and dry dishwasher-safe china and crystal. Check manufacturers' recommendation before washing.

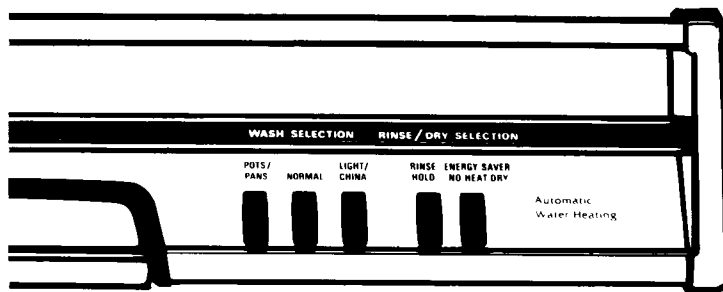

## RINSE/DRY SELECTIONS

**RINSE & HOLD CYCLE** is used to rinse partial loads of dishes until a full load is accumulated. No detergent is used. Dishware is kept moist until a complete wash and dry cycle can be run.

What happens during this cycle? This cycle provides one rinse.

**ENERGY SAVER — NO HEAT DRY** can be used with any Wash Selection to eliminate the heat during the dry portion of a cycle. The fan of the drying system will continue to operate, helping the dishes to air dry naturally. Under certain conditions, you may find a few drops of water on the dishware and silverware at the end of this cycle.

### TO CANCEL A CYCLE

The Cycle Selection Dial may be used to cancel any cycle in progress. If water is present in the dishwasher, turn the dial slowly to the drain portion of the wash or rinse. You will hear water draining when you have advanced to the proper location. Let the dishwasher drain completely. Lift the door handle and advance the dial to the

Pots/Pans cycle. This cancels the cycle.

If water is absent from the dishwasher, lift door handle to stop dishwasher action. Relatch door and advance dial to Pots/Pans cycle. This cancels the cycle.

### TO START A NEW CYCLE —

Open dishwasher; check detergent dispenser to be sure it is properly filled. Close and latch door; select the desired new cycle.

### ADDING DISHWARE DURING A CYCLE

You can add a forgotten item to the dishwasher anytime before the main detergent wash portion of the cycle. To stop the cycle, just unlatch the door handle. However, opening the door during a cycle reduces the cleaning power, so try to load all items before starting the cycle.

### TO RESTART DISHWASHER

Close the door and latch the handle, push cycle button originally selected and if desired, the Energy Saver button. The cycle will start exactly where it was stopped.



## SPECIAL TIPS ON DISHWASHER USE

### What Can and Cannot Be Washed in Your Dishwasher

Most tableware, cookware and silverware can be safely washed in your KitchenAid dishwasher. If you have any doubts about a particular piece of dishware, check with the manufacturer to see if it is dishwasher safe. If you cannot reach the manufacturer, simply test-wash a small item for several weeks before attempting to wash an entire set.

**REMEMBER: It is the user's responsibility to determine if dishware should be washed in a dishwasher.**

Material	Dishwasher Safe?	Exceptions/ Special Information	Material	Dishwasher Safe?	Exceptions/ Special Information
Aluminum	Yes	High water temperature and detergents may affect finish of anodized aluminum.	Pewter	No	High water temperatures and detergent may discolor or pit finish.
Cast Iron	No	Seasoning will be removed, and iron will rust.	Disposable Plastics	No	Cannot withstand high water temperatures and detergents.
China/ Stoneware	Yes	Always check manufacturers' recommendation before washing. Antique, hand-painted or over-the-glaze patterns may fade. Gold leaf may discolor. If in doubt, test-wash a small item for several weeks before washing an entire set.	Plastics	Yes	Always check manufacturers' recommendation before washing. Plastics vary in their capacity to withstand high water temperatures and detergents.
Crystal	Yes	Always check manufacturers' recommendation before washing. Some types of leaded crystal may etch with repeated washings. If in doubt, test-wash a small item for several weeks before washing an entire set.	Stainless Steel	Yes	Run a RINSE & HOLD CYCLE if not washing immediately. Prolonged contact with foods containing salt, vinegar, milk products or fruit juice could damage finish.
Dirilyte	No	Gold-colored flatware will discolor.	Sterling Silver or Silverplate	Yes	Run a RINSE & HOLD CYCLE if not washing immediately. Prolonged contact with food containing salt, acid or sulfide (eggs, mayonnaise and seafood) could damage finish.
Glass	Yes	Milk glass will yellow with repeated dishwasher washing.	Tin	No	May rust.
Hollow-Handle Knives	No	Handles of some knives are attached to the blade with adhesives which may loosen if dishwasher washed.	Wooden Ware	No	Always check manufacturers' recommendation before washing. Untreated wood may warp, crack or lose its finish.



## LOADING YOUR DISHWASHER

Your KitchenAid dishwasher is designed with lots of loading space. Glasses, mugs, saucers and saucepans can be loaded in either the upper or lower rack. For best results, dishware should be loaded so soiled surfaces face the rotating wash arm.

No hand rinsing is necessary before loading your KitchenAid dishwasher. *Just scrape* leftover food, bones, toothpicks and other hard items from the dishware.

Some foods like eggs, rice, pasta and cooked cereals may be hard to remove if left to dry over a period of time. If you do not plan to wash your dishes fairly soon after use, run a RINSE & HOLD CYCLE to keep them moist until you are ready to run the next wash cycle. Never prewash dishes with a hand dishwashing detergent. It will cause sudsing in the dishwasher and result in poor cleaning and/or spotting and filming on the dishware.

## LOADING YOUR DISHWASHER

### Adjustable Upper Rack

Your KitchenAid dishwasher features a 16-position upper rack which can easily be adjusted whether empty or full.

- Pull the upper rack out so the knobs on either side of the rack are easily reached.
- Pull knob on side of rack out from the retainer plate, raise or lower to desired level, and place knob pin into one of the four holes in the retainer.

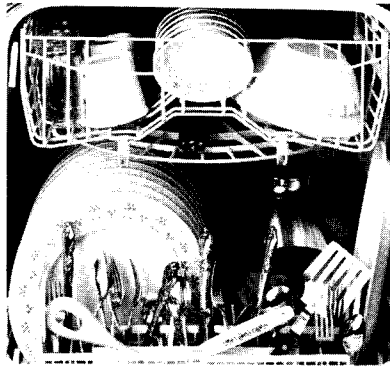
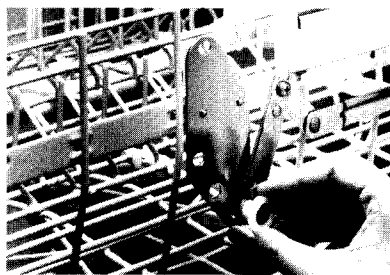

Use the *High Position* when loading platters, trays, large roasting pans and other baking utensils in the lower rack.

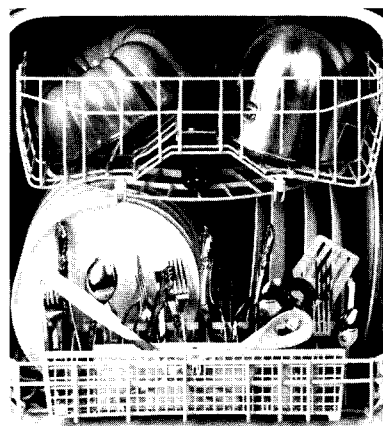

Use the *Low Position* when loading pitchers, deep bowls and tall stemware in the upper rack.

For a *Combination/Tilted Position*, either side of the rack may be raised or lowered independently of the other to accommodate extra large items in both racks.

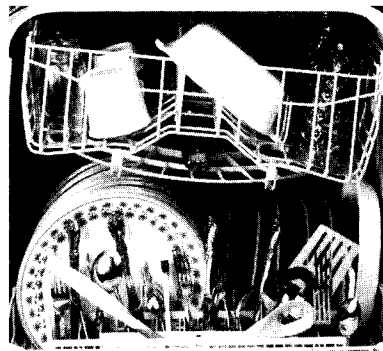

Items such as coffee cups and mugs with hollowed out bottom surfaces often collect water. For maximum drainage, load all such items on one side of the rack and tilt it down to aid in drying.

## UPPER RACK LOADING EXAMPLES

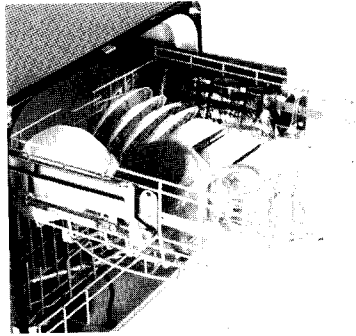

Glasses, stemware, bowls, pans and saucers may be loaded together. Stability is important when loading such items.

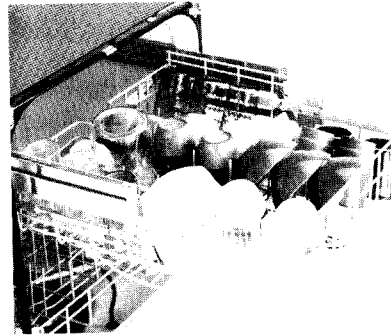

To achieve stability, load glasses and cups between pins and over pins. Bowls and cups may be loaded in the center row as shown.



## LOADING YOUR DISHWASHER

### LOWER RACK LOADING EXAMPLES

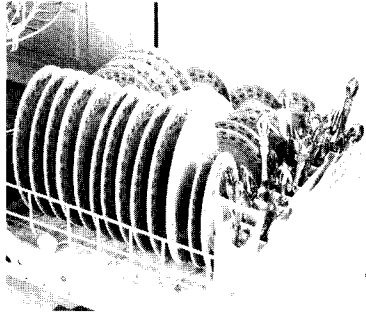

For maximum capacity and stability of an all-plate load, overlap or “butterfly” small plates on right side, as shown.

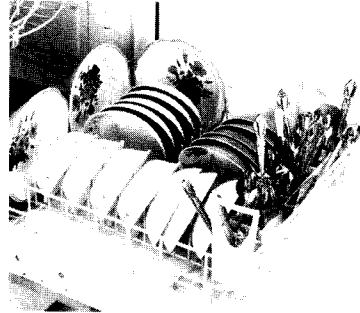

Cereal/soup bowls may be loaded in a variety of ways, depending upon the shape of the bowls.

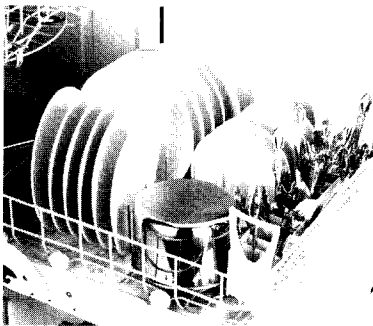

Plates may be loaded front to back or side to side with pots, pans and large cookware.

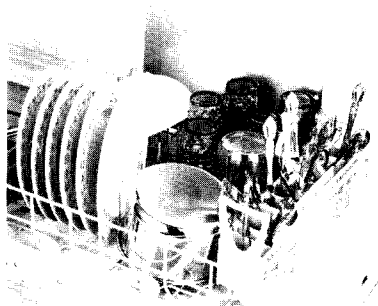

Glasses may be loaded in the upper or lower rack along with plates, bowls and saucepans.



## SILVERWARE BASKET

The silverware/cutlery basket can be removed for loading and unloading.

For best washing results:

- Load slim handled silverware with handles up to prevent them from protruding through the basket, possibly causing damage to the silverware or dishwasher.
- Sharp utensils should be loaded with handles up to prevent possible injury.

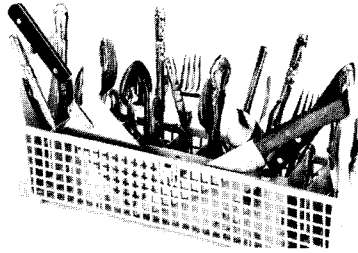

- The cutlery section in the front of the basket is for long-handled utensils and long knives.

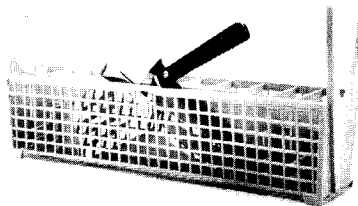

- Load forks and spoons with handles up and down so they do not nest together. Nested items cannot be properly washed.



**NOTE:** Silver and stainless steel flatware may be damaged if exposed to foods containing salt, vinegar, milk products or fruit juices for long periods of time. Use the RINSE & HOLD CYCLE if flatware is not washed immediately after use.



## FILLING THE DETERGENT DISPENSER

### Low Suds Mean High Performance

1. Use an automatic dishwasher detergent such as ALL, CASCADE, ELECTRASOL or FINISH. Never use soap, hand dishwashing detergent, laundry detergent or laundry enzyme products. They will produce excessive suds and slow down the wash arm action which could cause flooding.
2. Add detergent to the dispenser immediately before starting. Detergent exposed to moisture over a period of time may become caked and ineffective. An open box of detergent should stay fresh for about one month.
3. Fill the dispenser with the proper amount of detergent, and close the compartment.

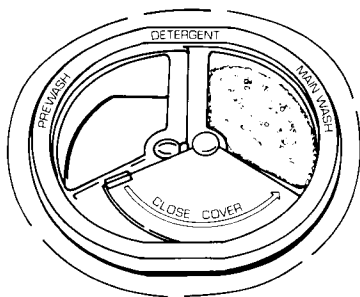

Fill the Main Wash compartment for the Light/China Wash Cycle when the dinnerware is lightly soiled.

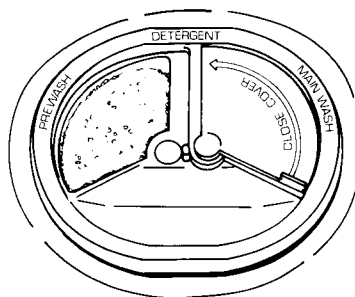

Fill both the Prewash and Main Wash compartments for the Light/China Wash Cycle, the Normal Wash Cycle and the Pots/Pans Cycle.

## HOW MUCH DETERGENT TO USE

### Some Hard Facts:

ALWAYS use at least one tablespoon of automatic dishwashing detergent in Main Wash compartment because there are ingredients in detergent to help protect your dinnerware. The amount of detergent needed depends on the amount of food soil on the dishes and the hardness of water. If you have hard water, you will have to use more detergent than if you have soft water. Excessive amounts of detergent combined with soft water may cause etching of glass.

Contact your local water utility, area water softening company or state university extension agent to determine whether your water is hard or soft.

WATER HARDNESS	AMOUNT OF DETERGENT
Soft Water 0-4 grains per gallon	Fill each dispenser half full (approximately 2 tablespoons per dispenser)
Medium Hard Water 4-8 grains per gallon	Fill each dispenser $\frac{3}{4}$ full (approximately 2½ tablespoons per dispenser)
Hard Water 8-12 grains per gallon	Fill each dispenser completely (approx- imately 3 tablespoons per dispenser)

## LOW PHOSPHATE DETERGENTS

If you live in a state that mandates low-phosphate dishwasher deter-

gents (phosphate content of 8.7 percent or less), you may have to use more detergent, particularly if you have hard water. Low-phosphate detergents usually work well in soft water, but in hard water they can cause spotting and filming, even if the amount of detergent used is increased.

## RINSE AGENTS

### Win the War Against Spotting

Your dishwasher uses a liquid rinse agent. A rinse agent helps water to sheet off dishware faster than normal, reducing water spots and speeding up the drying process.

To fill the rinse agent dispenser, unscrew the cap located to the left of the detergent dispenser. This reservoir will hold 7 fluid ounces of rinse agent, enough to last a few months. Be sure to replace the cap after filling the reservoir. A small amount of rinse agent is automatically released during the final rinse. Liquid rinse agents such as JET DRY are available in your local supermarket.

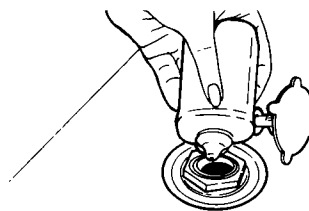

**WARNING: DISHWASHER  
DETERGENTS AND RINSE  
AGENTS CAN BE HARMFUL  
IF TAKEN INTERNALLY. FOR  
SAFETY'S SAKE, PLEASE  
STORE THESE PRODUCTS  
OUT OF CHILDREN'S REACH.**



## CARING FOR YOUR DISHWASHER

### A Clean Machine... General Cleaning

The porcelain enamel interior of your dishwasher will seldom need cleaning. However, if mineral deposits from hard water accumulate, clean the interior with a mild scouring powder such as BON AMI; or follow the suggestions indicated in the "To Remove Spots and Film" section on page 26.

The control panel can be wiped clean with a damp cloth, then dried. NEVER use detergents or abrasive or powdered cleansers which can mar the finish.

The enamel or wood fronts and sides can be cleaned with a soft cloth and a mild, non-abrasive soap and water solution. NEVER use paper towels for cleaning. Always dry with a soft cloth.

## SEASONAL STORAGE

### Closed for the Season... The Summer Season:

Two simple steps will safeguard your KitchenAid dishwasher during an idle summer:

1. Turn off the water supply.
2. Turn off electricity to the dishwasher.

### The Winter Season:

CAUTION: To protect against possible rupture of fill valve, BE SURE water lines leading to, as well as in the dishwasher, are well protected against freezing. RUPTURES OF THIS KIND ARE NOT COVERED BY THE WARRANTY.

To safeguard your KitchenAid dishwasher when it is exposed to freezing temperatures in a seasonal dwelling, have your local KitchenAid service person do the following:

1. Close and latch the door.
2. Turn off electricity to the dishwasher.
3. Shut off water supply. Place pan under fill valve, and disconnect fill valve at both inlet and outlet sides. Drain water into pan.
4. Place a pan under the check valve outlet, and disconnect the flexible tubing at the check valve. Drain machine water into pan. Leave fill and check valve disconnected.

To restore service, reconnect the fill valve and the connection at the check valve. Turn on the electricity and the water supply. Close and latch the door. Select the LIGHT/CHINA WASH CYCLE and let the machine complete its cycle. Check connections to make sure they are water tight and do not leak.

## Drain Air Gap

Some state or local plumbing codes require the addition of a drain air gap between a built-in dishwasher and the home drain system. This device protects your dishwasher against water backing up into it when a drain clogs. The drain air gap is usually located on top of the sink or countertop near the dishwasher.

**REMEMBER:** This external plumbing device is not part of your KitchenAid Dishwasher.

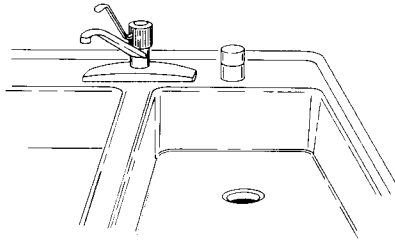

### To clean the drain air gap:

Clean the drain air gap periodically to insure proper drainage of your dishwasher. Follow drain air gap cleaning instructions provided by the manufacturer. With most types, just lift off the chrome cover, unscrew the plastic cap, and then check for any buildup of soil. Clean if necessary.

### Check the Air Gap Anytime Your Dishwasher Isn't Draining Well.

**REMEMBER:** The warranty provided with your dishwasher does not cover service costs directly associated with the cleaning or repair of the external drain air gap.



## SURE-CLEAN WASH SYSTEM

The Sure-Clean Wash System in your dishwasher provides the best washability with a minimum of care. The wash water is continuously filtered by a triple filtration and soil collector system to prevent food particles from redepositing on

The removable filter continuously filters the wash water and traps the food particles that have been removed from the dishes on the outside of the filter. These trapped food particles are removed from the filter by the jet spray action of water from the single spray nozzle (D) underneath the wash arm. The ultrafine filter is cleaned by the nine water jets (E) underneath the 4-Way Hydro Sweep Wash Arm.

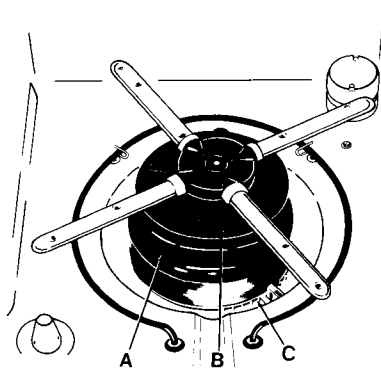

clean dishes. The triple filtration system consists of a removable filter (A), an ultrafine filter (B) and a removable coarse strainer (C).

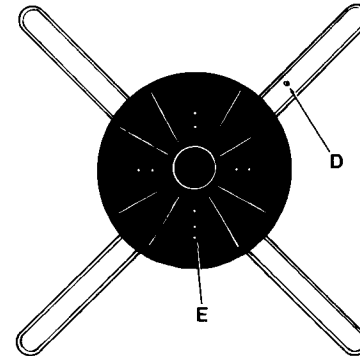

The removable coarse strainer (C) prevents bones, pits and other large objects from entering the pump system. Occasionally check the strainer for such items that may have mistakenly gotten into the dishwasher.

The 4-Way Hydro Sweep Wash Arm, the removable filter and the coarse strainer may be removed and cleaned if necessary. If food soils remain on the removable filter, lift the 4-Way Hydro Sweep Wash Arm straight up. Check underside of wash arm to make sure the opening of the single stainless steel spray nozzle (D) and the nine water jets (E) are not blocked. Next, remove the removable filter, by lifting

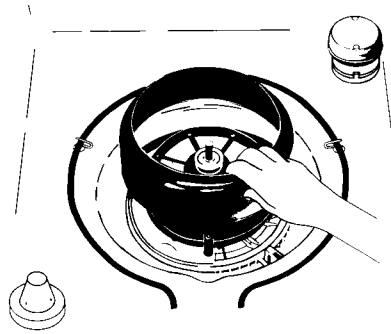

the filter straight up and out. TO CLEAN, scrub filter with a stiff brush under running water. TO REPLACE, snap removable filter over the ultrafine filter and then replace the wash arm. When replacing wash arm, be sure that water jets on the wash arm are facing up.

The coarse strainer may be removed if necessary. TO REMOVE, lift strainer out by squeezing center section (F) and remove. TO REPLACE, squeeze center section so clips snap into square notch.

The Overflow Protection Float (G) in the front left corner of the dishwasher tank prevents the dishwasher from overflowing. The float must be in place for the dishwasher to operate.

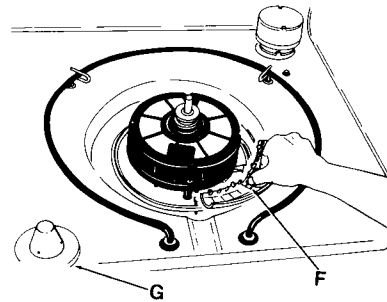

**NOTE:** A small amount of water always remains in the sump (under the ultrafine filter) to lubricate the seal.

## PROBLEM, CAUSE, SOLUTION CHART

### Look Here First...

A convenient checklist for handling minor performance problems. Go over this list before calling for service. If you can't solve your dishwasher's problem, turn to page 30 for service information.

PROBLEM	CAUSE	SOLUTION
Food Soil Left On Dishes	Slowdown of wash arm due to high suds	Use recommended dishwasher detergents only. Never use soap or laundry detergents. Add more dishwasher detergent to increase amount of suds-inhibitors.
	Improper loading	Follow loading instructions in dishwasher Use and Care Guide.
	Low water pressure due to insufficient fill	Home water pressure should be 20 to 120 psi for proper dishwasher fill. A booster pump on the water supply may be necessary if pressure is too low.
	Use of incorrect, too little or ineffective detergent	Use recommended dishwasher detergents only. Follow recommendations in Use and Care Guide for amounts; never use less than one tablespoon per load. Detergent must be fresh to be effective. Always store it in a cool, dry area, preferably in an airtight container.
	Detergent cakes in dispenser	Use fresh detergent only. Do not allow detergent to sit for several hours in a wet dispenser. Have dispenser checked to make sure it is working properly.
	Water temperature is too low	Turn home water heater up so water entering dishwasher is 120°F (49°C) minimum. See recommended procedure "To Check Water Temperature," page 9.
	Filter cleaning spray nozzle on wash arm is blocked	Remove lower wash arm and turn upside down. Check single stainless steel spray nozzle and nine water jets located on underside of wash arm. See page 22. Check to make sure openings are not blocked.
Spotting and Filming	Hard water or high mineral content in water	Conditioning the final rinse water with a liquid rinse agent helps eliminate spotting and filming. Keep the dispenser full with a rinse agent, such as JET DRY, at all times.
	Water temperature is too low	Turn home water heater up so water entering dishwasher is 120°F (49°C) minimum. See recommended procedure "To Check Water Temperature," page 9.
	Use of incorrect detergents	Use recommended dishwasher detergents only.
	Incorrect amount of detergent	Follow recommendations in dishwasher Use and Care Guide for amount. Heavy soil and/or hard water generally require extra detergent.
	Use of ineffective detergents	Detergent should be fresh. Store in a cool, dry place, preferably in an airtight container. Discard lumpy detergent.



PROBLEM	CAUSE	SOLUTION
Spotting and Filming	Insufficient fill caused by low water pressure	Home water pressure should be 20 to 120 psi for proper dishwasher fill. A booster pump on the water supply may be necessary if pressure is too low.
Cycle Takes Extremely Long Time	Water temperature is too low	Turn home water heater up so water entering dishwasher is 120°F (49°C) minimum. See recommended procedure "To Check Water Temperature," page 9.
Dishes Do Not Dry Completely	Dishes do not drain properly  Plastics	Dishes must have proper water drainage. Do not overload. Follow instructions for loading in dishwasher Use and Care Guide. Use a liquid rinse agent to speed draining.  Some plastics, due to material, may need to be towel dried.
Silica Film or Etching (Silica Film is a White Iridescent Deposit; Etching is a Cloudy Film)	A water chemical reaction with certain types of glassware. Usually caused by some combination of soft or softened water, alkaline washing solutions, insufficient rinsing, overloading the dishwasher, and heat of drying.	It may not be possible to prevent problem, except by hand washing. To retard this process, use a minimum amount of detergent but not less than one tablespoon per load. Use a liquid rinse agent and underload the dishwasher to allow thorough rinsing. Remove glasses from dishwasher before dry cycle. Silica film and etching are permanent and cannot be removed.
Black or Gray Marks on Dishes	Aluminum markings	Aluminum pieces should be loaded so that they will not rub against dinnerware during washing. Throw-away aluminum items should not be dishwasher washed because they may break down and cause marking. Aluminum markings can be removed by using a mild abrasive cleanser.
Brown Stains on Dinnerware and Dishwasher Interior	High iron content in water supply	Remove by washing dishes (after food soil has been removed) with 1 teaspoon to 1 tablespoon of citric acid crystals added to Main Wash compartment of detergent dispenser. Do not use detergent. Follow with a LIGHT/CHINA WASH CYCLE with detergent. If treatment is needed more often than every other month, the installation of an iron removal unit is recommended.
White Spots on Cookware with Non-Stick Finish	Seasoning removed by dishwasher detergents	Re-season cookware after dishwasher washing.
Odor in the Dishwasher	Dishes only washed every two to three days	Run a RINSE & HOLD CYCLE at least once or twice a day until a full load is accumulated.
Chipping of Dishware	Improper loading	Load dishes and glasses so that they are stable and do not strike together from washing action. (Note: Some types of china and glassware are too delicate for automatic dishwashing and should be hand washed; for example: antiques, featheredged and similar types.) Moving racks in and out smoothly will also minimize chipping.

## PROBLEM, CAUSE, SOLUTION CHART

PROBLEM	CAUSE	SOLUTION
Removable Filter Needs Frequent Cleaning	Filter is not placed in dishwasher correctly	Make sure Removable filter is seated properly under wash arm. See page 23.
	Spray nozzle on wash arm is blocked	Remove lower wash arm—see page 23—and turn upside down. On under side of each tube is an indentation. In one of these indentations is a nozzle (hole) which cleans filter. Check to make sure the nozzle is not blocked.
	Dishes not scraped before loading	Make sure leftover food, bones, toothpicks and other hard items are scraped from dinnerware before loading.

### To Remove Spots and Film:

To remove spots and film on dishware and glasses, or hard water film on the interior of the dishwasher, you may want to use stripping products such as LIME-A-WAY or GLASS MAGIC. These products are available in the detergent section of your local grocery store; follow the manufacturers' directions.

Or you may use vinegar with the following procedure:

1. Load clean dishes and glasses in dishwasher in regular manner. Do not load silverware or other metals in the dishwasher.
2. Close and latch door and select LIGHT/CHINA WASH CYCLE. Do not use detergent. Allow dishwasher to run through the

first wash. When washer has filled for main wash portion of cycle, unlatch and open door. Add 2 cups of household vinegar. Close and latch door and re-select LIGHT/CHINA WASH CYCLE.

3. After final rinse water has drained, cancel cycle. Do not allow dishwasher to go through dry portion of cycle.
4. For a final polish, put two tablespoons of non-precipitating type water conditioner (such as CALGON) in the right-hand Main Wash compartment of detergent dispenser, and run dishwasher through complete LIGHT/CHINA WASH CYCLE.

## CHANGING FRONT PANELS

### A new look...

Your new KitchenAid dishwasher comes with a stainless steel trim kit and two front panels installed one behind the other. You can choose from almond or white (front and back of one panel) and onyx black or harvest wheat (front and back of the second panel). The dishwasher has been shipped with the almond panel showing.

If you want to change the color of the panels, follow one of the options below. Option A may be used if your dishwasher front protrudes several inches from the cabinets. Option B may be used if your dishwasher front is flush with the cabinets.

**WARNING:** TO PREVENT ELECTRICAL SHOCK, disconnect electrical power supply to dishwasher before changing panels.

### OPTION A UPPER PANEL:

1. Pull door open and on either side of the dishwasher door, remove the three screws (A) from the trim (B). Remove the loosened piece of trim.
2. Slide the panel out. Handle carefully so the panels will not be scratched or bent. Turn the panel to the desired color. Place the color panel in position then push the filler panel in behind it.
3. Replace the trim (B) and the three screws (A).

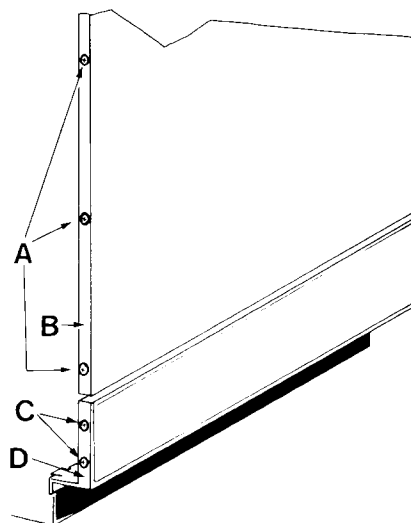

### LOWER PANEL:

1. Remove the two screws (C) on either side of the lower panel. Remove the loosened piece of trim (D).
2. Slide the panel out. Handle carefully so the panels will not be scratched or bent. Turn the panel to the desired color. Place the color panels in position then push the filler panel in behind it.
3. Replace the trim (D) and the two screws (C).

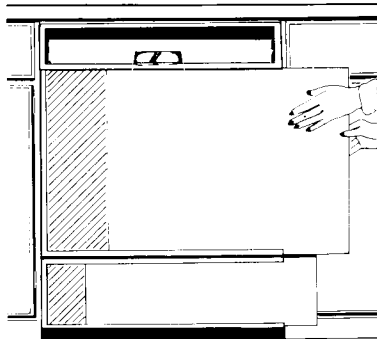



## OPTION B UPPER PANEL:

1. Pull door open. Remove the two screws (A) on each side of the dishwasher door that secure the upper panel assembly.
2. Close door while holding upper panel in place. Pull out lower edge of panel until top edge of panel drops down.
3. Place panel on a smooth, flat surface and remove three screws (B) from either side of panel to remove the trim strip (C).
4. Slide the panel out. Handle carefully so the panel will not be scratched or bent. Turn the panel to the desired color. Place the color panel in position then push the filler panel in behind it.
5. Replace the trim strip and the three screws.
6. With hands placed at sides of panel, slide the top edge of the panel up into position under the control panel (see illustration to the right).
7. Hold the panel in place and open the door.
8. Hold panel in position with one hand. Replace the two screws (A) on each side of the dishwasher door that secure the panel assembly.

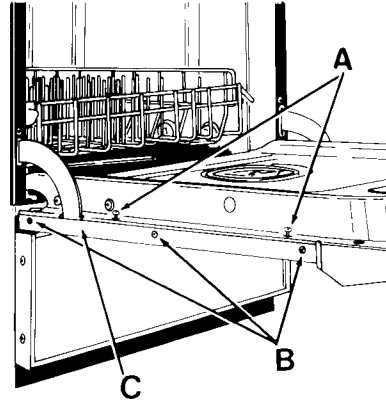



### Lower Panel:

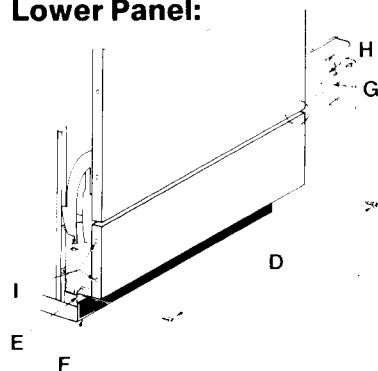

1. Remove two screws (D) located under panel.
2. With hands placed under ends of panel, lift support tabs (E) and pull out until tabs clear kick plate (F).
3. Pull lower panel down until side flanges (G) clear the support strip (H). Lower panel is then removed from dishwasher.
4. Place panel on a smooth, flat surface and remove the two screws (I) from either side of the trim. Take off the loosened piece of trim.
5. Slide the panel out. Handle carefully so the panel will not be scratched or bent. Turn the panel to the desired color. Place the color panel in position then push the filler panel in place.
6. Replace the trim and screws (I).
7. Taking the assembled lower panel, slide the panel up onto the dishwasher front so that the side flanges (G), fit up behind the support strip (H). If this is done improperly, the lower

panel will be loose and may fall off the dishwasher.

8. Lift support tabs (E) of panel up and push lower portion of panel back until support tabs (E) rest on kick plate (F).
9. Replace the screws (D).
10. Check that upper and lower panels are secure.
11. Reconnect electrical power supply.

## OPTIONAL FRONT PANELS

### More to Choose From

1. Wood and Decorative Panels  
The stainless door trim will accommodate a custom wood front or a decorative panel insert, 1/4 inch thick. Some wood panels and decorative panels are heavy and require heavy dishwasher door springs. These may be ordered from your KitchenAid dealer as a service item, part #240418. For more information on installing a custom wood front, refer to the Dishwasher Installation instructions. If you have misplaced these instructions, please write to:

Manager  
Consumer Affairs  
KitchenAid, Inc.  
3800 Space Drive  
Dayton, Ohio 45414-9990

2. Solid Colors  
If the four colors provided with your dishwasher do not match your kitchen decor, optional panels are available from your KitchenAid dealer in a variety of decorator colors.



## WHEN YOU NEED SERVICE

### Follow These Steps

1. If your dishwasher should fail to operate, review the following list before calling your dealer. You could save the cost of a service call.

Has a fuse blown, or is the circuit breaker open?

Is the door closed and latched and a cycle selected?

Is the overflow protection float in place? See page 23.

Is the water supply to the dishwasher turned on?

2. If your dishwasher is not washing properly, refer to the Problem, Cause, Solution chart on page 24 before you make a service call.
3. If the problem is not due to one of the above items, see "How To Arrange For Service" listed in the Warranty Statement.
4. If you are not satisfied with the action taken, contact the Major Appliance Consumer Action Panel (MACAP). MACAP is a group of independent consumer experts that voices consumer views at the highest levels of the major appliance industry. Contact them only when the dealer,

authorized servicing outlet, wholesale distributor and KitchenAid have failed to resolve your problem.

Major Appliance Consumer  
Action Panel  
20 North Wacker Drive  
Chicago, IL 60606

MACAP will in turn inform us of your action.

In all correspondence about your dishwasher, please include:

- Date
- Your Name, Address and Telephone Number
- Type of Appliance
- Brand
- Model Number
- Serial Number
- Date Purchased
- Dealer from Which Purchased (include address)
- Servicing Agent (include name and address if different from dealer's)
- Location of Appliance
- A Clear Description of the Problem and the Service Required

[REDACTED]

[REDACTED]  
[REDACTED]  
[REDACTED]  
[REDACTED]  
[REDACTED]  
[REDACTED]  
[REDACTED]  
[REDACTED]  
[REDACTED]

## KITCHENAID WARRANTY

### KD-21 Series Dishwasher

LENGTH OF WARRANTY:	KITCHENAID WILL PAY FOR:	KITCHENAID WILL NOT PAY FOR:
<b>ONE YEAR FULL WARRANTY</b> FROM DATE OF INSTALLATION	Replacement parts and repair labor to correct defects in materials or workmanship. Service must be provided by a KitchenAid wholesale distributor or by one of their authorized KitchenAid servicing outlets.	A. Service calls to: 1. Correct the installation of the dishwasher. 2. Instruct you how to use the dishwasher. 3. Replace house fuses or correct house wiring. 4. Correct house plumbing.
<b>FIVE YEAR LIMITED WARRANTY</b> ONE YEAR FULL PLUS SECOND THROUGH FIFTH YEAR LIMITED	Replacement parts (labor costs not included) for the one-half horsepower motor if defective in materials or workmanship.	B. Repairs when dishwasher is used in other than normal home use.
<b>TEN YEAR LIMITED WARRANTY</b> ONE YEAR FULL PLUS SECOND THROUGH TENTH YEAR LIMITED FROM DATE OF INSTALLATION	Replacement parts (labor costs not included) for the TriDura™ Porcelain-on-steel tank or inner door if the tank or inner door develops a water leak as the result of defective materials or workmanship.	C. Damage resulting from accident, alteration, misuse, abuse, improper installation or installation not in accordance with local electrical and plumbing codes. D. Any labor costs during limited warranty. E. Replacement parts or repair labor costs for units operated outside the United States.

#### KITCHENAID, INC. DOES NOT ASSUME ANY RESPONSIBILITY FOR INCIDENTAL OR CONSEQUENTIAL DAMAGES.

Some states do not allow the exclusion or limitation of incidental or consequential damages, so this exclusion or limitation may not apply to you.

This warranty gives you specific legal rights and you may also have other rights which vary from state to state.

#### HOW TO ARRANGE FOR SERVICE

- First call your dealer or repair service he recommends.
- If for some reason he is not available, or if you now reside in an area other than where the unit was purchased, look in the yellow pages of your phone book under "Dishwashing Machines" for authorized KitchenAid servicing outlets.
- If you are unable to obtain satisfactory service, contact the KitchenAid wholesale distributor. He is listed in the yellow pages of all metro area phone books under "Dishwashing Machines."
- All service should be handled locally by the dealer from whom you purchased the unit or an authorized KitchenAid servicing outlet or wholesale distributor. If your local service is not satisfactory, contact Consumer Affairs, KitchenAid, Inc., 3800 Space Drive, Dayton, Ohio 45414-9990, Phone 513-454-6800.

4177728